

Measuring wheel systems

Compact-Line	Measuring wheel system MWE21	With spring arm, contact force max. 20 N
---------------------	-------------------------------------	---



With incremental or absolute encoder with clamping flange \varnothing 36 mm or \varnothing 40 mm.

Measuring wheel systems from Kübler are the ideal solution for reliable speed measurement, position detection and length measurement in applications with linear movements. These are recorded rotationally via the measuring wheel with attached encoder directly on the surface of the material to be measured and converted into linear data.

The compact measuring wheel system MWE21 with adjustable preload can be integrated very flexibly even in the tightest installation spaces.

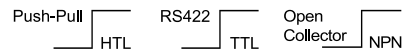

Analog output



CANopen



Features

- Compact measuring wheel system**
 For the tightest installation spaces with flexible mounting options: vertical, horizontal or overhead. Encoders can be mounted on both sides of the spring arm in 30° steps.
- Wide range of encoders**
 Incremental Sendix encoder with a max. resolution of up to 2500 pulses/revolution as well as absolute encoders for different communication interfaces such as IO-Link for integration in Industry 4.0 concepts.
- Suitable measuring wheels for all measuring surfaces**
 Circumference 200 mm or 6" - measuring wheel coating available with O-ring, smooth plastic or diamond knurl surface.
- Contact force up to max. 20 N**
 With adjustable preload and mechanical spring deflection limitation for a long service life. The integrated spring ensures a working range of the measuring wheel of up to 16 mm vertical to the measuring surface to compensate for tolerances.

Construction

- ❶ Spring arm: MWE20
- ❷ Mounting bracket: optional
- ❸ Encoder: Clamping flange \varnothing 36 mm or \varnothing 40 mm
- ❹ Measuring wheel: Circumference 200 mm or 6"

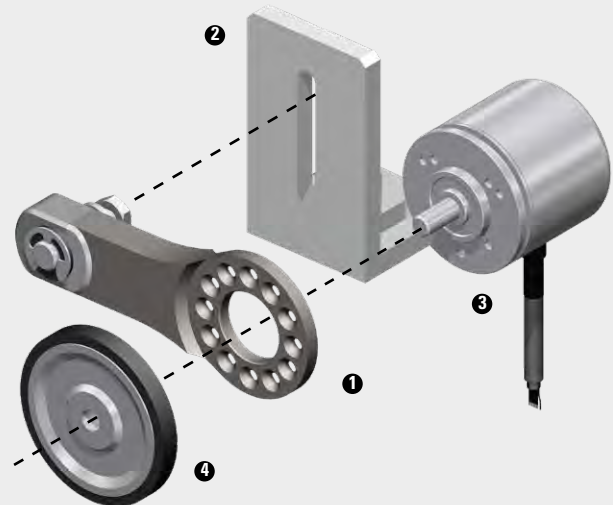

Measuring wheel systems

Compact-Line Measuring wheel system MWE21 With spring arm, contact force max. 20 N

Order code with incremental encoder **8.MWE21 . 1 X 1 . XX . 40 XX . XXXX**

Type ① ② ③ ④ ⑤ ⑥ ⑦

① Encoder version
1 = incremental

② Mounting bracket
1 = without mounting bracket
2 = with mounting bracket

③ Measuring wheel, circumference / coating
21 = 200 mm / diamond knurl (aluminum)
24 = 200 mm / plastic smooth (PU)
27 = 200 mm / O-ring (NBR)

61 = 6" / diamond knurl (aluminum)
64 = 6" / plastic smooth (PU)
67 = 6" / O-ring (NBR)

(other measuring wheels on request)

④ Mounted encoder ¹⁾
40 = KIS40 incremental
(other encoders on request)

⑤ Output circuit / supply voltage encoder
see data sheet encoder

⑥ Type of connection
see data sheet encoder

⑦ Pulse rate
see data sheet encoder

Order code with absolute encoder **8.MWE21 . 2 X 1 . XX . XXXX . XXXX**

Type ① ② ③ ④ ⑤ ⑥ ⑦ ⑧ ⑨

① Encoder version
1 = absolute

② Mounting bracket
1 = without mounting bracket
2 = with mounting bracket

③ Measuring wheel, circumference / coating
21 = 200 mm / diamond knurl (aluminum)
24 = 200 mm / plastic smooth (PU)
27 = 200 mm / O-ring (NBR)

61 = 6" / diamond knurl (aluminum)
64 = 6" / plastic smooth (PU)
67 = 6" / O-ring (NBR)

(other measuring wheels on request)

④ Mounted encoder ¹⁾
M1 = M3661 Analog output
M3 = M3663 SSI
M8 = M3668 CANopen
M8 = M3668 IO-Link
(other encoders on request)

⑤ Output circuit / supply voltage encoder
see data sheet encoder

⑥ Type of connection
see data sheet encoder







⑦ + ⑧ + ⑨ Interface specifications
see data sheet encoder

Calculation of the linear resolution

	Measuring step (distance/pulse)		Resolution (pulses/distance)	
Calculation	$\frac{\text{distance}}{\text{ppr}}$	$= \frac{\text{Measuring wheel circumference}}{\text{Pulse number encoder}}$	$\frac{\text{ppr}}{\text{distance}}$	$= \frac{\text{Pulse number encoder}}{\text{Measuring wheel circumference}}$
Example 1 Measuring wheel circumference = 200 mm Pulse number encoder = 1000 ppr	$\frac{200 \text{ mm}}{1000 \text{ ppr}}$	$= 0.2 \text{ mm / puls}$	$\frac{1000 \text{ ppr}}{200 \text{ mm}}$	$= 5 \text{ pulses / mm}$
Example 2 Measuring wheel circumference = 6 inch Pulse number encoder = 600 ppr	$\frac{6 \text{ inch}}{600 \text{ ppr}}$	$= 0.01 \text{ inch / puls}$	$\frac{600 \text{ ppr}}{6 \text{ inch}}$	$= 100 \text{ pulses / inch}$

1) Clamping flange 36 or 40 mm / shaft ø 6 mm - only relevant for ordering an encoder as a single component.

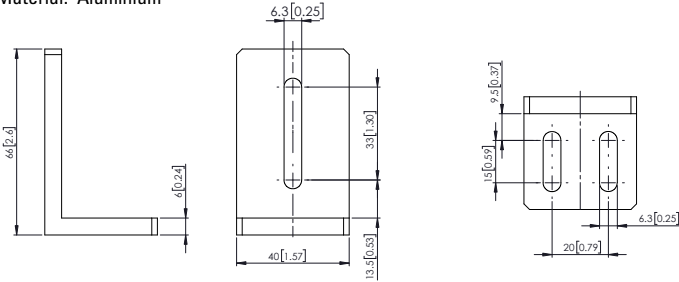
Measuring wheel systems

Compact-Line		Measuring wheel system MWE21	With spring arm, contact force max. 20 N
Single components			Order no.
Spring arm MWE20		combinable with Kübler encoders: incremental: Sendix Base KIS40, 3610 absolute: Sendix F36xx, M36xx	8.MWE20.111.00.0000.0000 8.MWE20.211.00.0000.0000
			
Measuring wheels		Option ③ circumference / coating	
		21 200 mm / diamond knurl (aluminum)	8.0000.3215.0006
		24 200 mm / plastic smooth (PU)	8.0000.3245.0006
		27 200 mm / O-ring (NBR70)	8.0000.3275.0006
		61 6" / diamond knurl (aluminum)	8.0000.3615.0006
		64 6" / plastic smooth (PU)	8.0000.3645.0006
		67 6" / O-ring (NBR70)	8.0000.3675.0006
		(other measuring wheels on request)	
Evaluation			Order no.
Preset counter Codix 924		Multifunction device: - Tachometer with limit values - Position indicators with limit values - Time preset counter	6.924.01XX.XXX
			
Accessories			Order no.
Mounting bracket		Material: Aluminium	8.0000.7000.0065
			
O-rings		For measuring wheel circumference 200 mm For measuring wheel circumference 6"	8.0000.7000.0067 8.0000.7000.0066
			

Further accessories can be found at: kuebler.com/accessories
Cables and connectors can be found at: kuebler.com/connection-technology

Measuring wheel systems

Compact-Line	Measuring wheel system MWE21	With spring arm, contact force max. 20 N
---------------------	-------------------------------------	---

Technology in detail

Mounting options encoder on spring arm

The encoder is attached to the spring arm with 3 screws.



The fastening points are designed in such a way that mounting on both sides of the spring arm is possible.



Mounting left (delivery state)



Mounting right

For a flexible outlet direction of the cable or connector, the encoder can additionally be mounted in 30° steps.



0° (delivery state)



30°



60°



90°

Various mounting options

horizontally

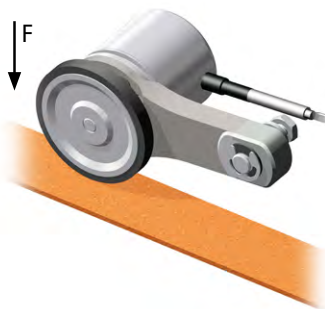

vertically



overhead

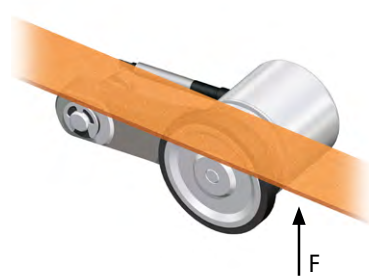

Contact force of the measuring wheel on the material to be measured

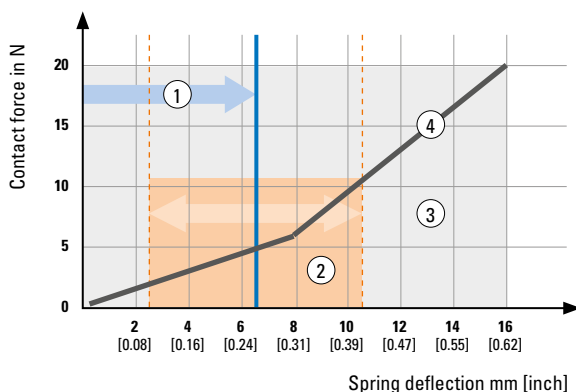

- 1 Preload, example: 5 N (approx. 6,5 mm deflection)
- 2 Operating travel, recommended: ± 4 mm (from the preload set)
- 3 Spring deflection, max.: 16 mm
- 4 Contact force in relation to spring deflection (Functional principle based on 2 integrated springs)

Measuring wheel systems

Compact-Line	Measuring wheel system MWE21	With spring arm, contact force max. 20 N
---------------------	-------------------------------------	---

Technical data

Mechanical characteristics spring arm MWE21

Materials	spring spring arm	spring steel aluminum
Weight	37 g	
Contact force, max.	20 N	
Spring deflection, max.	16 mm	
Preload, recommended	5 N (approx. 6,5 mm spring deflection)	
Operating travel, recommended (continuous)	±4 mm ¹⁾ (from the recommended preload)	
Spring operating life	2.0 Mio. cycles ²⁾	

Approvals

UL compliant in accordance with File no. E224618

CE compliant in accordance with
 EMC Directive 2014/30/EU
 RoHS Directive 2011/65/EU

UKCA compliant in accordance with
 EMC Regulations S.I. 2016/1091
 RoHS Regulations S.I. 2012/3032

1) Operating deflection is measured after preload applied and with/for continuous operations.

2) Life of spring is measured with operating deflection at 1 Hz.

Measuring wheel systems

Compact-Line

Measuring wheel system MWE21

With spring arm, contact force max. 20 N

Dimensions

Dimensions in mm [inch]

Spring arm MWE20 in combination with measuring wheel and encoder KIS40

- 1 Fixing screw M4 x 6 for measuring wheel
- 2 Hexagon nut M6
- 3 Toothed washer
- 4 Encoder

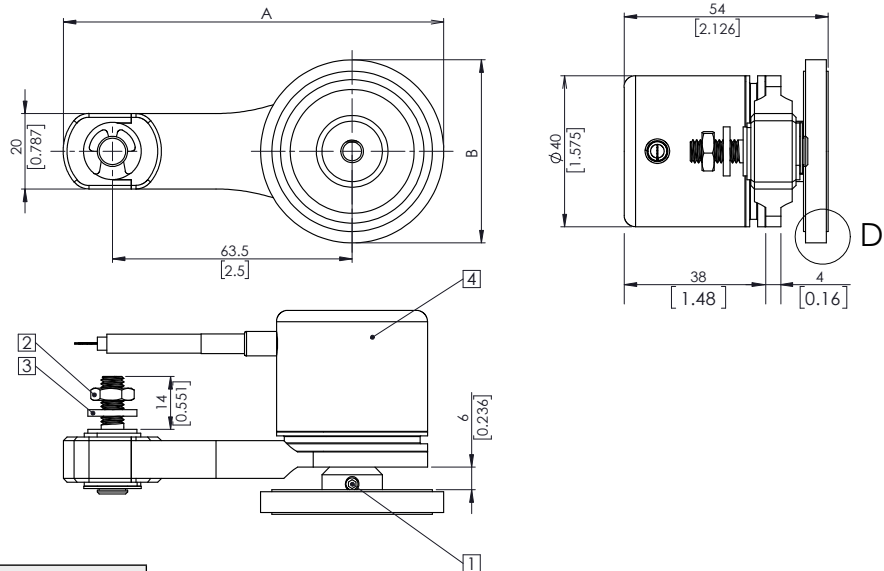

Measuring wheel circumference	A mm [inch]	ø B mm [inch]
200 mm	108.4 [4.27]	63.7 [2.52]
6"	100.8 [3.97]	48.5 [1.91]

D for measuring wheel with coating:

Diamond knurl (aluminum)

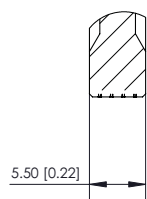

Plastic smooth (PU)

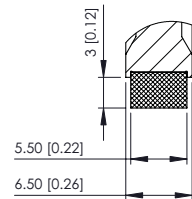

O-ring (NBR)

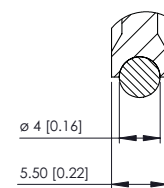

Mounting bracket

